



ABB India Helpline.

Technical Telephone support for
customers and channel partners.
Toll Free: (BSNL) +91 1800 420 07 07.

abb.com





Switch to the future

IVIE range of modular switches

IVIE is the latest premium modular range of wiring accessories designed to address various functionalities. These include basic switching, controlling, comfort and energy saving.

The IVIE range innovatively matches your interiors and aesthetically brings out the best in your comfort zone. The enhanced design for reliable performance of this range is for the passionate, compassionate, intuitive and magnetic personality within each one of us.

The IVIE range, includes the tastefully selected color options, caters to the needs of various segments like residential, commercial and hospitality.

IVIE with its ability to integrate home automation solutions in your existing switch box, makes the range future proof.

IVIE truly makes you want to switch to the future.

Table of contents

04	Sleek and convex design in different finishes
05	Flexibility in design which provides total control
06	Wide range of applications
09–11	Features and benefits
13	IVIE Installation System
	IVIE complete range
14–18	IVIE mechanisms - White
19–22	IVIE mechanisms - Anthracite Grey
23–26	IVIE mechanisms - Silver
26	Metal boxes
27	IVIE ABB-free@home® home automation
	Dimensions and circuit connection diagrams
29–30	Dimensional details
31	Circuit connection diagrams

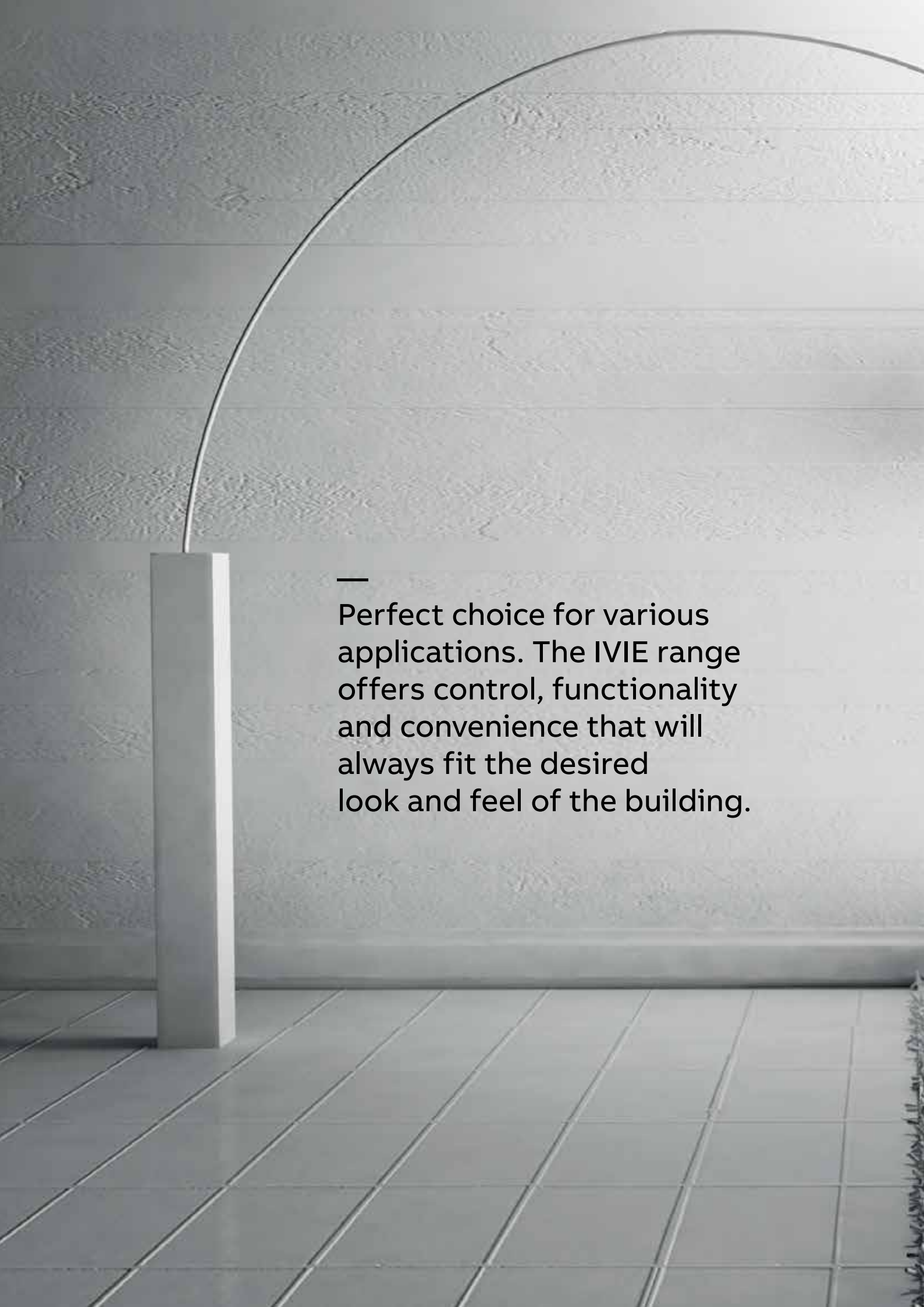

—
Perfect choice for various applications. The IVIE range offers control, functionality and convenience that will always fit the desired look and feel of the building.



Sleek and convex design in different finishes

Thanks to the complete system, The Ivie series provides a comprehensive range of solutions for building concepts. The convex and sleek design not only provides quality and style to the overall building, but is easy to install.



01



02



03

Different finishes and combinations:

- 01 Anthracite grey mechanisms in Silver plate
- 02 Silver mechanisms in Anthracite Grey plate
- 03 Anthracite grey mechanisms in White plate



Flexibility in design which provides total control

The IVIE range is the first Indian range to incorporate wired and wireless home automation systems together. This range can be integrated with ABB-free@home® home automation system, which is the most intelligent way of managing spaces with energy saving.

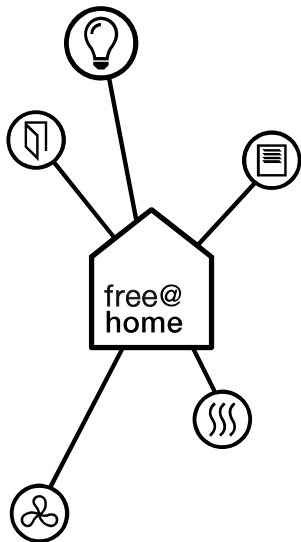
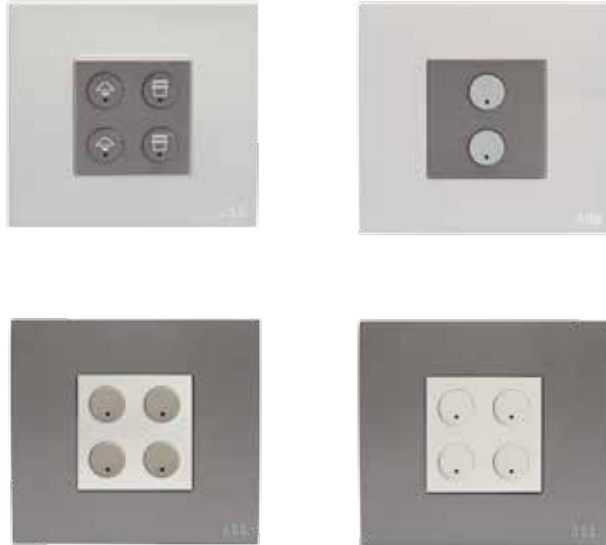

Great comfort, safety and energy efficiency for buildings

ABB-free@home® sensor for switching control, blind control, dimming and scene control.



Wide range of applications

IVIE range is a flexible concept which creates a very comprehensive range, suitable for any type of application. This makes the range an ideal and best choice for all types of residential, commercial and hotel buildings.



Residential

Simple and comprehensive design which integrates with any type of architecture, regardless of the home decor. Provides a wealth of features and values. Thanks to its wide range of functions and benefits.



Commercial

IVIE range offers an elegant look designed for various applications like office spaces, warehouses, stores and shopping malls etc.



Hotels

IVIE range is ideal for the hospitality industry. Modern design and functionalities provide a high level of comfort to guests.





Features and benefits

Innovation, design and technology range with real international concepts

IVIE's design and functionality convert into numerous technical and installation advantages.



Modern and latest finishes in white, silver, anthracite and colours of your choice.



Convex profile plate with less projected sleek design is a perfect match for any architecture. Dust free surface and a slim design, not only add to the quality, but also provide a stylish look.

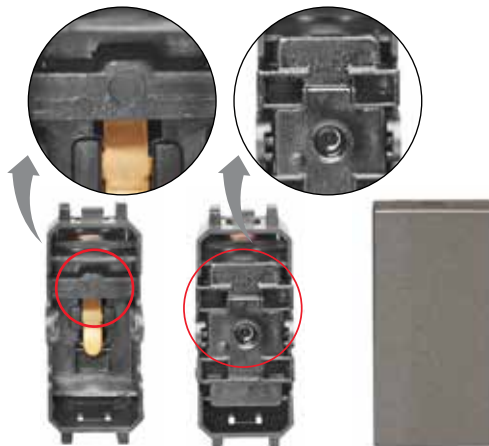

Double shrouded internal mechanism under the rocker, totally preventing visibility of sparks.



Terminal screws with Combihead for star/flat screw drivers.



Large variety of sockets, equipped with shutters for increased safety. Compatible for 6/16A two pin plug.



Universal regulator with 360 degree rotation.



Features and benefits

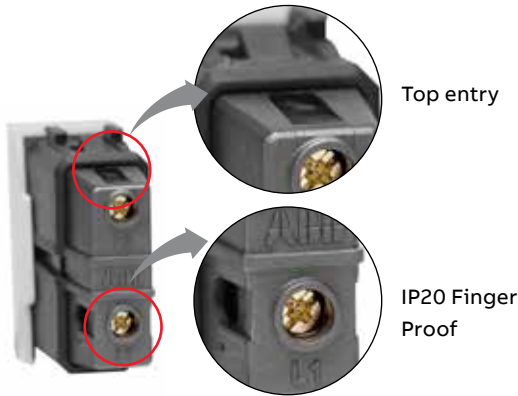

Top entry

IP20 Finger Proof

IP20 Finger Proof for total safety, user friendly terminal design-easy terminal accessibility by top entry to load connection.

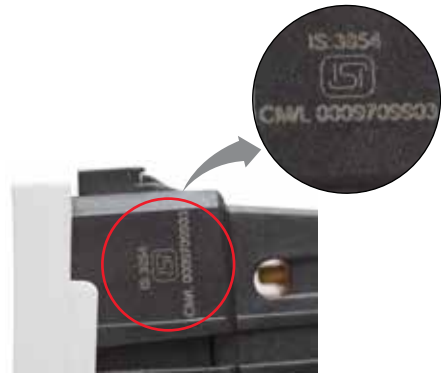

ISI marking on switch socket and fan regulator.

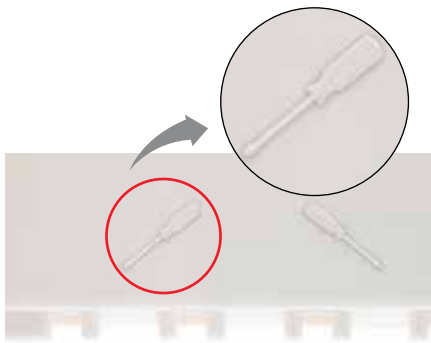

Visual signs provided in inner grids to guide proper fitment of easy installation and easy removal during fitment of mechanism with inner grid.



Independent shutter for earth and phase+neutral for child safety and easy connection.



Resin frame with extra ribs provides better mechanical strength, insulation resistance and corrosive proof.

Features and benefits

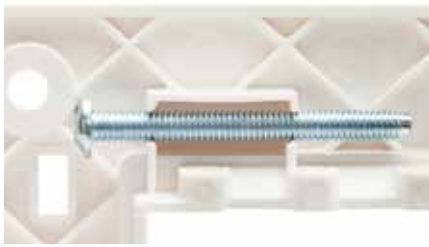

Mounting screws press fitted in back side screw holder to prevent loosening of the same.

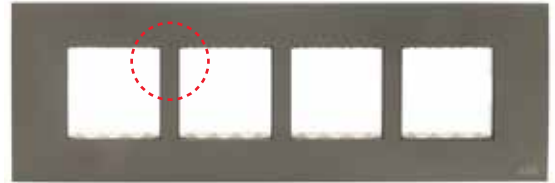

Two module partition is provided for sturdiness with extra ribs to ensure better strength of the frame.

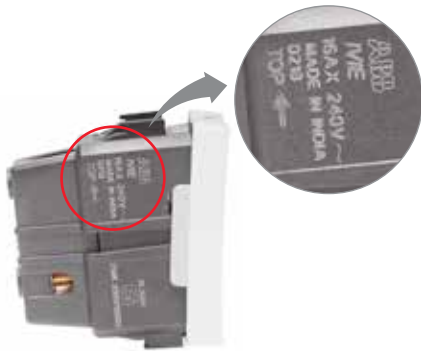

Laser marking and arrow showing the correct orientation of the mechanism.



IVIE incorporates full range of ABB-free@home® home automation and gives answers to the future by providing comfort, safety and energy savings.

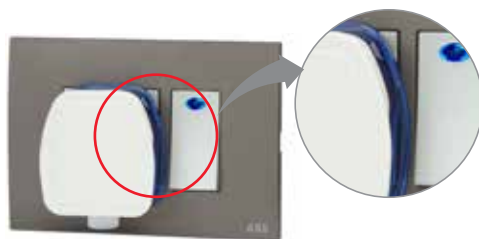

Suitable design for a variety of plug tops - no overlapping on the mechanism fitted next to the socket.



ABB warranty policy for IVIE range

- 10 years for mechanical switches and sockets
- One year for electronic devices



IVIE installation system

IVIE series is a grid type system enabling combination of colours and products of different dimensions and functionalities, together with ABB-free@home® sensors that have to be composed with the required frame, in order to have the right assortment of functionality and design.

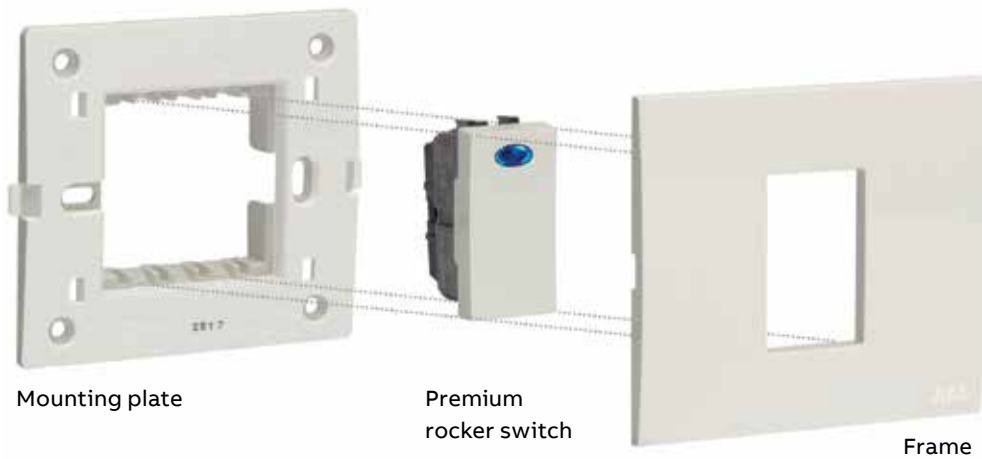

Euro White



Anthracite Grey



Silver

IVIE

complete range

IVIE mechanisms - White



1SYK100001A1001

Ordering code	Type reference and description	Number of modules	Pack
Switch 6 A - 240 V ~			
1SYK100001A1001	IIS10610 BL - 6A 1 way switch	1	20/400
1SYK100001A1002	IIS10620 BL - 6A 2 way switch	1	20/400



1SYK100001A1007

Ordering code	Type reference and description	Number of modules	Pack
Switch 16 A - 240 V ~			
1SYK100001A1006	IIS11610 BL - 16A 1 way switch	1	20/400
1SYK100001A1007	IIS1161L BL - 16A 1 way switch with indicator	1	20/400



1SYK100001A1008

Ordering code	Type reference and description	Number of modules	Pack
Switch 32 A - 240 V ~			
1SYK100001A1008	IIS2321L BL - 32A, DP switch	2	10/200



1SYK100001A1003 1SYK100001A1005

Ordering code	Type reference and description	Number of modules	Pack
Bell Push			
1SYK100001A1003	IIS106B0 BL - 6A Bell switch	1	20/400
1SYK100001A1004	IIS106BL BL - 6A Bell switch with indicator	1	20/400
1SYK100001A1005	IIS206BL BL - 6A Mega Bell switch with indicator	2	10/200



1SYK100001A1021



1SYK100001A1022



1SYK100001A1023

Ordering code	Type reference and description	Number of modules	Pack
Sockets			
1SYK100001A1021	IHK20006 BL - 6A, 2+3 pin socket	2	10/200
1SYK100001A1022	IHK20613 BL - 6/13A universal socket	2	10/200
1SYK100001A1023	IHK20616 BL - 6/16A socket	2	10/200
1SYK100001A1024	IHK20620 BL - 6/20A socket	2	10/200
1SYK100001A1025	IHK20625 BL - 6/25A socket	2	10/200
1SYK100001A1026	IHK10006 BL - 6A 2 pin socket	1	20/400
2CLA223800N1102	N2238 BL - Euro-American earthed socket outlet, 125/250V AC, 15/16A, 2 P+E	2	10
2CLA213500N1102	N2135 BL - Euro-American unearthed socket outlet, 125/250V AC, 15/16A, 2 P	1	20
2CLA223700N1102	N2237 BL - British standard socket outlet, 250V AC, 13A, 2 P+E	2	10

IVIE mechanisms - White

Ordering code	Type reference and description	Number of modules	Pack
USB chargers			
2CLA218500N1102	N2185 BL - USB charger 0.75A, 100-240V	1	1
2CLA218520N1102	N2185.2 BL - USB charger 2A, 100-230V	1	1
2CLA228500N1102	N2285 BL - USB charger 1.5A, 100-240V	2	1
Blank plates			
1SYK100001A1041	IIM1BLNK BL - blank plate	1	20/400
Dimmer & fan regulators			
1SYK100001A1042	IIM2FR05 BL - step fan regulator 5 step	2	5/100
1SYK100001A1043	IIM1FR04 BL - step fan regulator 4 step	1	10/200
1SYK100001A1045	IIM2D400 BL - dimmer 400 watt	1	10/200
2CLA226020N1102	N2260.2 BL - Universal rotatory/push dimmer • 230V, rated voltage: 230 V AC • Max. power: incandescent: 500 Watt halogen lamp with electronic transformer: 500 VA • Halogen lamp with ferromagnetic transformer: 400 VA	2	1
2CLA226030N1102	N2260.3 BL - LED rotatory/push dimmer, 230V • Rated voltage: 230 V AC • Nominal power: 250 W/VA Power (min./max load): LEDi: 2/100 W/VA (max. 10 lamps) • Dimmable energy saving lamps: 2/100 W/VA (max. 10 lamps) • LV LEDi with transformer (only type L or LC): 4/100 W/VA (max. 10 lamps) • Incandescent lamps: 10/250 W/VA • Halogen lamps: 10/250 W/VA. • LV halogen with transformer (only type L or LC): 10/250 W/VA (max. 10 lamps) • 2 wire connection. Optional: auxiliary on/off with 2-way switch N2X02	2	1
2CLA226080N1102	N2260.8 BL - LED rotatory/push dimmer • Rated voltage: 127 V AC, Frequency: 50/60 Hz (Nominal power: 140 W/VA) • Power (min./max load): LEDi: 2/55 W/VA (max. 10 lamps) • Dimmable energy saving lamps: 2/55 W/VA (max. 10 lamps) • LV LEDi with transformer (only type L or LC): 4/55 W/VA (max. 10 lamps) • Incandescent lamps: 10/140 W/VA • Halogen lamps: 10/140 W/VA • LV halogen with transformer (only type L or LC): 10/140 W/VA (max. 10 lamps)	2	1
2CLA226090N1102	N2260.9 BL - 1-10V rotary dimmer • Rated voltage: 127 - 230 V AC/50 - 60 Hz • Max. power: 230 Vac: 700 VA • 127 V AC: 350 VA • Max. 6 ballasts per device	2	1
Data & voice			
1SYK100001A1047	IIM1RJ11 BL - RJ11 Tel. jack 2 pin	1	20/400
1SYK100001A1048	IIM1RJ45 BL - RJ45 Jack cat 6	1	20/400
TV Socket			
1SYK100001A1049	IIM1TVSK BL - TV co-axial socket	1	20/400

IVIE mechanisms - White



1SYK100001A1051

Ordering code	Type reference and description	Number of modules	Pack
Starters			
1SYK100001A1051	IIM2ST20 BL - Single Phase Starter 20A	2	5/100
1SYK100001A1052	IIM2ST25 BL - Single Phase Starter 25A	2	5/100



1SYK100001A1057

Ordering code	Type reference and description	Number of modules	Pack
Shaver socket			
1SYK100001A1057	IIM2SVSK BL - Shaver Socket	2	5/100



1SYK100001A1055

Ordering code	Type reference and description	Number of modules	Pack
DND & MMR			
1SYK100001A1055	IIM1DNDS BL - DND and MMR set internal & external	2+3	5/100



2CLA224450 N1102 2CLA218050N1102 2CLA218040N1102

2CLA224450 N1102	N2244.5 BL - DND and MUR 2-gang interlocked switch	2	5
2CLA218050N1102	N2180.5 BL - LED MUR signaling light	1	5
2CLA218040N1102	N2180.4 BL - LED DND signaling light	1	5



2CLA221410N1102

Ordering code	Type reference and description	Number of modules	Pack
Key card switches			
2CLA221410N1102	N2214.1 BL - Card switch 1-gang, 1-way, DP	2	1



1SYK100001A1059

Ordering code	Type reference and description	Number of modules	Pack
Down lighter			
1SYK100001A1059	IIM3DOWN BL-down lighter	3	5/100



2CLA215520 N1102

2CLA215530 N1102

Ordering code	Type reference and description	Number of modules	Pack
Audio & video connector			
2CLA215520N1102	N2155.2 BL - 2x RCA connection unit	1	1
2CLA215530N1102	N2155.3 BL - 3x RCA connection unit	1	1



2CLA215540 N1102

2CLA215560 N1102

2CLA215540N1102	N2155.4 BL - Mini-Jack connection unit	1	1
2CLA215550N1102	N2155.5 BL - VGA connection unit	1	1
2CLA215560N1102	N2155.6 BL - HDMI connection unit	1	1
2CLA215570N1102	N2155.7 BL - HDMI female-female connection unit	1	1
2CLA215580N1102	N2155.8 BL - USB connection unit	1	1
2CLA215590N1102	N2155.9 BL - USB female-female connection unit	1	1

IVIE mechanisms - White



2CLA224100N1102

Ordering code	Type reference and description	Number of modules	Pack
Motion sensor			
2CLA224100N1102	N2241 BL - 110° motion sensor • Max. power: Incandescent: 1,800W @230V AC/1,000W @127V AC • Halogen with electronic or ferromagnetic transformer: 750VA @230V AC/400VA @127V AC - Fluorescent lamps or motors: 400VA @230V AC/200VA @127V AC • For automatic switching of devices dependent on motion and brightness • With integrated selector switch for automatic ON-OFF in the front side • Switch-off delay: 10 sec to 10 min or short-time pulse 1 sec adjustable (from the front side) • Detection range: 5 m radius • Adjustable light set point level for activation (from the front side) • Detection angle: 110° Mounting height: 1, 2 m Auxiliary control with N2X04.X push-buttons	2	1



1SYK100001A1054

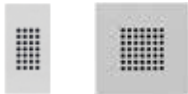

2CLA211900 N1102 2CLA221900 N1102

Ordering code	Type reference and description	Number of modules	Pack
Buzzer & door bell			
1SYK100001A1054	IIM2BUZR BL - Buzzer	2	5/100
2CLA211900N1102	N2119 BL - Buzzer	1	1
2CLA221900N1102	N2219 BL - Buzzer	2	1
2CLA222400N1102	N2224 BL - Electronic door bell 230 V AC	2	1



1SYK100001A1053

Ordering code	Type reference and description	Number of modules	Pack
Indicator			
1SYK100001A1053	IIM1INDI BL - Indicator	1	20/400



2CLA218000N1602

Ordering code	Type reference and description	Number of modules	Pack
Signaling light			
2CLA218000N1102	N2180 BL - LED white signaling light, Lamp: white LED Luminous flux: > 2 lumen at 1 meter, white diffuser	1	5
2CLA218000N1602	N2180 RJ - LED red signaling light, Lamp: white LED Luminous flux: > 2 lumen at 1 meter, Red diffuser	1	1
2CLA218000N1802	N2180 VD - N2180 VD, Lamp: white LED Luminous flux: > 2 lumen at 1 meter, Green diffuser	1	1
2CLA228000N1102	N2280 BL - LED signaling light, Lamp: white LED Luminous flux: > 2 lumen at 1 meter, White diffuser	2	1
2CLA228100N1102	N2281 BL - Beacon LED light, Lamp: white LED Luminous flux: > 2 lumen at 1 meter, white diffuser, Autonomy: 3 hours (1 hour at maximum illumination 2 hours with lower illumination), Battery: Ni-MH (estimated lifetime: 4 years)	2	1

IVIE mechanisms - White

2CLA814050
A10022CLA224050
N1102

Ordering code	Type reference and description	Number of modules	Pack
Thermostat			
2CLA814050A1002	8140.5 - Digital room thermostat • Maximum load: 3A cos = 0,5 • Output relay operation modes: Hysteresis: 0.5° C • Pulse-width modulation: with a ±4°C difference with the set-point temperature • Variable from 100% to 0% modulation • To be installed with N2240.5 cover plates	2	1
2CLA224050N1102	N2240.5 BL - Cover plate for digital thermostat - 2M	2	1



2CLA936810A1001

2CLA936820
A10012CLA225710
N1102

Ordering code	Type reference and description	Number of modules	Pack
Sound			
2CLA936810A1001	9368.1 - Multiroom sound module	1	1
2CLA936820A1001	9368.2 - Remote control for multiroom sound module	2	1
2CLA226800N1102	N2268 BL - Cover plate for radio/remote control modules	-	1
2CLA936800A1001	9368- FM - Radio and alarm module	2	1
2CLA226800N1102	N2268 BL - Cover plate for radio/remote control modules	-	1
2CLA936830A1001	9368.3 - Auxiliary module	2	1
2CLA226830N1102	N2268.3 BL - Cover plate for I/O + USB + Bluetooth module	-	1
2CLA225710N1102	N2257.1 BL - Speaker connection unit	2	1

* More details will be provided upon request

1SYK100001
A10711SYK100001
A10721SYK100001
A10731SYK100001
A1074

1SYK100001A1077



1SYK100001A1079

Ordering code	Type reference and description	Number of modules	Pack
White plate with frame			
1SYK100001A1071	IIP0133 BL - 1M plate	1	15/360
1SYK100001A1072	IIP0233 BL - 2M plate	2	15/360
1SYK100001A1073	IIPP343 BL - 3M plate power	3	10/240
1SYK100001A1074	IIP0343 BL - 3M plate	3	10/240
1SYK100001A1075	IIP0453 BL - 4M plate	4	10/190
1SYK100001A1076	IIP0683 BL - 6M plate	6	5/120
1SYK100001A1077	IIP0893 BL - 8M plate	8	5/120
1SYK100001A1078	IIP0855 BL - 8M plate square	8	5/95
1SYK100001A1079	IIP1286 BL - 12M plate	12	5/95
1SYK100001A1080	IIP1888 BL - 18M plate	18	5/40

IVIE

complete range

IVIE mechanisms - Anthracite Grey



1SYK100001A1201

Ordering code	Type reference and description	Number of modules	Pack
Switch 6 A - 240 V ~			
1SYK100001A1201	IIS10610 AN - 6A 1 way switch	1	20/400
1SYK100001A1202	IIS10620 AN - 6 A 2 way switch	1	20/400



1SYK100001A1207

Ordering code	Type reference and description	Number of modules	Pack
Switch 16 A - 240 V ~			
1SYK100001A1206	IIS11610 AN - 16A 1 way switch	1	20/400
1SYK100001A1207	IIS1161L AN - 16A 1 way switch with ind.	1	20/400



1SYK100001A1208

Ordering code	Type reference and description	Number of modules	Pack
Switch 32 A - 240 V ~			
1SYK100001A1208	IIS2321L AN - 32A, DP switch	2	10/200



1SYK100001 A1203 1SYK100001 A1205

Ordering code	Type reference and description	Number of modules	Pack
Bell Push - 240 V ~			
1SYK100001A1203	IIS106B0 AN - 6A Bell Switch	1	20/400
1SYK100001A1204	IIS106BL AN - 6A Bell Switch with ind.	1	20/400
1SYK100001A1205	IIS206BL AN - 6A Mega Bell switch with ind.	2	10/200



1SYK100001A1221

Ordering code	Type reference and description	Number of modules	Pack
Sockets - 240 V ~			
1SYK100001A1221	IHK20006 AN - 6A, 2+3 pin socket	2	10/200
1SYK100001A1222	IHK20613 AN - 6/13A universal socket	2	10/200
1SYK100001A1223	IHK20616 AN - 6/16A socket	2	10/200
1SYK100001A1224	IHK20620 AN - 6/20A socket	2	10/200
1SYK100001A1225	IHK20625 AN - 6/25A socket	2	10/200
1SYK100001A1226	IHK10006 AN - 6A 2 pin socket	1	20/400
2CLA223800N1802	N2238 AN - Euro-American earthed socket outlet, Rated current: 15/16A, 2P+E/NEMA 5-15R	2	10
2CLA213500N1802	N2135 AN - Euro-American unearthed socket outlet, Rated current: 15/16A, 2P (non-earthed)/NEMA 1-15R	1	20
2CLA223700N1302	N2237 AN - British standard socket outlet, Rated current: 13A, 2P+E	2	10



1SYK100001A1222



1SYK100001 A1223 1SYK100001 A1226

IVIE mechanisms - Anthracite Grey

2CLA218500
N1802

Ordering code	Type reference and description	Number of modules	Pack
USB chargers			
2CLA218500N1802	N2185 AN - USB charger 750mA, 1-gang	1	1
2CLA218520N1802	N2185.2 AN - USB charger 2.000mA, 1-gang	1	1
2CLA228500N1802	N2285 AN - USB charger 1.500mA, 2-gang	2	1



1SYK100001A1241

Ordering code	Type reference and description	Number of modules	Pack
Blank plates			
1SYK100001A1241	IIM1BLNK AN - Blank plate	1	20/400



1SYK100001A1242

Ordering code	Type reference and description	Number of modules	Pack
Dimmer & fan regulators			
1SYK100001A1242	IIM2FR05 AN - Step fan regulator 5 step	2	5/100
1SYK100001A1243	IIM1FR04 AN - Step fan regulator 4 step	1	10/200
1SYK100001A1245	IIM1D400 AN - Dimmer 400 Watt	1	10/200



2CLA226020N1802

2CLA226020N1802	N2260.2 AN - Universal rotatory/push dimmer • Rated voltage: 230 V AC • Max. power: Incandescent: 500 W • Halogen lamp with electronic transformer: 500 VA • Halogen lamp with ferromagnetic transformer: 400 VA	2	1
-----------------	--	---	---



2CLA226030N1802

2CLA226030N1802	N2260.3 AN - LED rotatory/push dimmer • Rated voltage: 230 V AC • Nominal power: 250 W/VA • Power (min./max load): LEDi: 2/100 W/VA (max. 10 lamps). Dimmable energy saving lamps: 2/100 W/VA (max. 10 lamps) • LV LEDi with transformer (only type L or LC): 4/100 W/VA (max. 10 lamps) • Incandescent lamps: 10/250 W/VA • Halogen lamps: 10/250 W/VA • LV halogen with transformer (only type L or LC): 10/250 W/VA (max. 10 lamps) • 2 wire connection • Optional: auxiliary on/off with 2-way switch N2X02	2	1
-----------------	---	---	---



2CLA226080N1802

2CLA226080N1802	N2260.8 AN - LED rotatory/push dimmer • Rated voltage: 127 V AC • Frequency: 50/60 Hz (Nominal power: 140 W/VA) • Power (min./max load): LEDi: 2/55 W/VA (max. 10 lamps) • Dimmable energy saving lamps: 2/55 W/VA (max. 10 lamps) • LV LEDi with transformer (only type L or LC): 4/55 W/VA (max. 10 lamps) • Incandescent lamps: 10/140 W/VA • Halogen lamps: 10/140 W/VA • LV halogen with transformer (only type L or LC): 10/140 W/VA (max. 10 lamps)	2	1
-----------------	--	---	---



2CLA226090N1802

2CLA226090N1802	N2260.9 AN - 1-10V rotary dimmer • Rated voltage: 127 - 230 V AC / 50 - 60 Hz • Max. power: 230 V AC: 700 VA • 127 V AC: 350 VA • Max. 6 ballasts per device	2	1
-----------------	--	---	---



1SYK100001A1247

Ordering code	Type reference and description	Number of modules	Pack
Data & Voice			
1SYK100001A1247	IIM1RJ11 AN - RJ11 Tel. jack 2 pin	1	20/400
1SYK100001A1248	IIM1RJ45 AN - RJ45 Jack cat 6	1	20/400



1SYK100001A1249

Ordering code	Type reference and description	Number of modules	Pack
TV Socket			
1SYK100001A1249	IIM1TVSK AN - TV co-axial socket	1	20/400

IVIE mechanisms - Anthracite Grey



1SYK100001A1257

Ordering code	Type reference and description	Number of modules	Pack
Shaver Socket			
1SYK100001A1257	IIM2SVSK AN - Shaver Socket	2	5/100



1SYK100001A1255

Ordering code	Type reference and description	Number of modules	Pack
DND & MMR			
1SYK100001A1255	IIM1DNDS AN - DND and MMR set internal & external	2+3	5/100
2CLA224450N1802	N2244.5 AN - DND and MUR 2-gang interlocked switch	2	1
2CLA218050N1802	N2180.4 AN - LED MUR signaling light	1	1
2CLA218040N1802	N2180.4 AN - LED DND signaling light	1	1



2CLA221410N1802

Ordering code	Type reference and description	Number of modules	Pack
Key Card Switches			
2CLA221410N1802	N2214.1 AN - Card switch 1-gang, 1-way, DP	2	1



1SYK100001A1259

Ordering code	Type reference and description	Number of modules	Pack
Down lighter			
1SYK100001A1259	IIM3DOWN AN - Down lighter	3	5/100

2CLA215520
N18022CLA215530
N1802

Ordering code	Type reference and description	Number of modules	Pack
Audio & Video Connector			
2CLA215520N1802	N2155.2 AN - 2x RCA connection unit	1	1
2CLA215530N1802	N2155.3 AN - 3x RCA connection unit	1	1
2CLA215540N1802	N2155.4 AN - Mini-Jack connection unit	1	1
2CLA215550N1802	N2155.5 AN - VGA connection unit	1	1
2CLA215560N1802	N2155.6 AN - HDMI connection unit	1	1
2CLA215570N1802	N2155.7 AN - HDMI female-female connection unit	1	1
2CLA215580N1802	N2155.8 AN - USB connection unit	1	1
2CLA215590N1802	N2155.9 AN - USB female-female connection unit	1	1

2CLA215540
N18022CLA215550
N18022CLA215560
N18022CLA215580
N1802

Ordering code	Type reference and description	Number of modules	Pack
Motion Sensor			
2CLA224100N1802	N2241 AN - 110° motion sensor • Max. power: Incandescent: 1.800W @230V AC/1.000W @127V AC • Halogen with electronic or ferromagnetic transformer: 750VA @230V AC/400VA @127V AC • Fluorescent lamps or motors: 400VA @230V AC/200VA @127V AC • For automatic switching of devices dependent on motion and brightness • With integrated selector switch for automatic ON-OFF in the front side • Switch-off delay: 10 sec. to 10 min. or short-time pulse 1 sec adjustable (from the front side) • Detection range: 5 m radius Adjustable light set point level for activation (from the front side) • Detection angle: 110° Mounting height: 1, 2 m auxiliary control with N2X04.X push-buttons	2	1

IVIE mechanisms - Anthracite Grey

2CLA211900
N18022CLA221900
N1802

Ordering code	Type reference and description	Number of modules	Pack
Buzzer & Door Bell			
1SYK100001A1254	IM2BUZR AN - Buzzer	2	5/100
2CLA211900N1802	N2119 AN - Buzzer	1	1
2CLA221900N1802	N2219 AN - Buzzer	2	1
2CLA222400N1802	N2224 AN - Electronic door bell 230 V AC	2	1

Ordering code	Type reference and description	Number of modules	Pack
Indicator			
1SYK100001A1253	IIM1INDI AN - Indicator	1	20/400

Ordering code	Type reference and description	Number of modules	Pack
Thermostat			
2CLA224050N1802	N2240.5 AN - Cover plate for digital thermostat	2	1

1SYK100001
A12711SYK100001
A1272

Ordering code	Type reference and description	Number of modules	Pack
Anthracite plate with frame			
1SYK100001A1271	IIP0133AN - 1M plate	1	15/360
1SYK100001A1272	IIP0233 AN - 2M plate	2	15/360
1SYK100001A1273	IIPP343 AN - 3M plate power	3	10/240
1SYK100001A1274	IIP0343 AN - 3M plate	3	10/240
1SYK100001A1275	IIP0453 AN - 4M plate	4	10/190
1SYK100001A1276	IIP0683 AN - 6M plate	6	5/120
1SYK100001A1277	IIP0893 AN - 8M plate	8	5/120
1SYK100001A1278	IIP0855 AN - 8M plate square	8	5/95
1SYK100001A1279	IIP1286 AN - 12M plate	12	5/95
1SYK100001A1280	IIP1888 AN - 18M plate	18	5/40

1SYK100001A1273

1SYK100001A1274



1SYK100001A1277

IVIE

complete range

IVIE mechanisms - Silver



SYK100001A1101

Ordering code	Type reference and description	Number of modules	Pack
Switch 6 A - 240 V ~			
1SYK100001A1101	IIS10610 PL - 6A 1 way switch	1	20/400
1SYK100001A1102	IIS10620 PL - 6A 2 way switch	1	20/400



1SYK100001A1107

Ordering code	Type reference and description	Number of modules	Pack
Switch 16 A - 240 V ~			
1SYK100001A1106	IIS11610 PL - 16A 1 way switch	1	20/400
1SYK100001A1107	IIS1161L PL - 16A 1 way switch with Ind.	1	20/400



1SYK100001A1108

Ordering code	Type reference and description	Number of modules	Pack
Switch 32 A - 240 V ~			
1SYK100001A1108	IIS2321L PL - 32A, DP switch	2	10/200



1SYK100001A1121

Ordering code	Type reference and description	Number of modules	Pack
Sockets - 240 V ~			
1SYK100001A1121	IHK20006 PL - 6A, 2+3 pin socket	2	10/200
1SYK100001A1122	IHK20613 PL - 6/13A universal socket	2	10/200
1SYK100001A1123	IHK20616 PL - 6/16A socket	2	10/200
1SYK100001A1124	IHK20620 PL - 6/20A socket	2	10/200
1SYK100001A1125	IHK20625 PL - 6/25A socket	2	10/200
1SYK100001A1126	IHK10006 PL - 6A 2 pin socket	1	20/400
2CLA223800N1302	N2238 PL - Euro-American earthed socket outlet, Rated voltage: 125/250 Vac, Rated current: 15/16A. 2P+E/NEMA 5-15R	2	10
2CLA213500N1302	N2135 PL - Euro-American unearthed socket outlet, Rated voltage: 125/250 V AC, Rated current: 15/16A. 2P (non-earthed)/NEMA 1-15R	1	20
2CLA223700N1802	N2237 PL - British standard socket outlet, Rated current: 13A, 2P+E	2	10



1SYK100001A1122

1SYK100001
A11231SYK100001
A11262CLA218500
N13022CLA228500
N1302

Ordering code	Type reference and description	Number of modules	Pack
USB Chargers			
2CLA218500N1302	N2185 PL - USB charger 750mA, 1-gang	1	1
2CLA218520N1302	N2185.2 PL - USB charger 2.000mA, 1-gang	1	1
2CLA228500N1302	N2285 PL - USB charger 1.500mA, 2-gang	2	1

IVIE mechanisms - Silver

Ordering code	Type reference and description	Number of modules	Pack
Blank Plates			
1SYK100001A1141	IIM1BLNK PL - Blank Plate	1	20/400



1SYK100001A1142

Ordering code	Type reference and description	Number of modules	Pack
Dimmer & Fan Regulators			
1SYK100001A1142	IIM2FR05 PL - Step fan regulator 5 step	2	5/100
1SYK100001A1143	IIM1FR04 PL - Step fan regulator 4 step	1	10/200
1SYK100001A1145	IIM1D400 PL - Dimmer 400 Watt	1	10/200



2CLA226030N1302

2CLA226020N1302	N2260.2 PL - Universal rotary/push dimmer • Rated voltage: 230 V AC • Max. power: Incandescent: 500 W • Halogen lamp with electronic transformer: 500 VA • Halogen lamp with ferromagnetic transformer: 400 VA.	2	1
-----------------	---	---	---



2CLA226030N1302

2CLA226030N1302	N2260.3 PL - LED rotary/push dimmer 230 V AC • Rated voltage: 230 V AC, Nominal power: 250 W/VA • Power (min./max load): LEDi: 2/100 W/VA (max. 10 lamps) • Dimmable energy saving lamps: 2/100 W/VA (max. 10 lamps) • LV LEDi with transformer (only type L or LC): 4/100 W/VA (max. 10 lamps) • Incandescent lamps: 10/250 W/VA • Halogen lamps: 10/250 W/VA • LV halogen with transformer (only type L or LC): 10/250 W/VA (max. 10 lamps) • 2 wire connection • Optional: auxiliary on/off with 2-way switch N2X02	2	1
-----------------	---	---	---



2CLA226080N1302

2CLA226080N1302	N2260.8 PL - LED rotary/push dimmer 127 V AC • Rated voltage: 127 V AC, Frequency: 50/60 Hz (Nominal power: 140 W/VA) • Power (min./max load): LEDi: 2/55 W/VA (max. 10 lamps) • Dimmable energy saving lamps: 2/55 W/VA (max. 10 lamps) • LV LEDi with transformer (only type L or LC): 4/55 W/VA (max. 10 lamps) • Incandescent lamps: 10/140 W/VA • Halogen lamps: 10/140 W/VA • LV halogen with transformer (only type L or LC): 10/140 W/VA (max. 10 lamps)	2	1
-----------------	--	---	---



2CLA226090N1302

2CLA226090N1302	N2260.9 PL - 1-10V rotary dimmer • Rated voltage: 127 - 230 V AC/50 - 60 Hz • Max. power: 230 Vac: 700 VA • 127 Vac: 350 VA • Max. 6 ballasts per device	2	1
-----------------	--	---	---



1SYK100001A1147

Ordering code	Type reference and description	Number of modules	Pack
Data & Voice			
1SYK100001A1147	IIM1RJ11 PL - RJ11 Tel. jack 2 pin	1	20/400
1SYK100001A1148	IIM1RJ45 PL - RJ45 Jack cat 6	1	20/400



1SYK100001A1149

Ordering code	Type reference and description	Number of modules	Pack
TV Socket			
1SYK100001A1149	IIM1TVSK PL - TV co-axial socket	1	20/400



1SYK100001A1157

Ordering code	Type reference and description	Number of modules	Pack
Shaver Socket			
1SYK100001A1157	IIM2SVSK PL - Shaver Socket	2	5/100

IVIE mechanisms - Silver



2CLA218040N1302

Ordering code	Type reference and description	Number of modules	Pack
DND & MMR			
1SYK100001A1155	IIM1DND5 PL - DND and MMR set internal & external	2+3	5/100
2CLA224450N1302	N2244.5 PL - DND and MUR 2-gang interlocked switch	1	1
2CLA218040N1302	N2180.4 PL - LED DND signaling light	2	1
2CLA218050N1102	N2180.4 BL - LED MUR signaling light	1	1



2CLA221410N1302

Ordering code	Type reference and description	Number of modules	Pack
Key Card Switches			
2CLA221410N1302	N2214.1 PL - Card switch 1-gang, 1-way, DP	2	1



1SYK100001A1159

Ordering code	Type reference and description	Number of modules	Pack
Down Lighter			
1SYK100001A1159	IIM3DOWN PL - Down lighter	2	5/100

2CLA215520
N13022CLA215530
N1302

Ordering code	Type reference and description	Number of modules	Pack
Audio & Video Connector			
2CLA215520N1302	N2155.2 PL - 2x RCA connection unit	1	1
2CLA215530N1302	N2155.3 PL - 3x RCA connection unit	1	1
2CLA215540N1302	N2155.4 PL - Mini-Jack connection unit	1	1
2CLA215550N1302	N2155.5 PL - VGA connection unit	1	1
2CLA215560N1302	N2155.6 PL - HDMI connection unit	1	1
2CLA215570N1302	N2155.7 PL - HDMI female-female connection unit	1	1
2CLA215580N1302	N2155.8 PL - USB connection unit	1	1
2CLA215590N1302	N2155.9 PL - USB female-female connection unit	1	1

2CLA215540
N13022CLA215550
N13022CLA215560
N13022CLA215580
N1302

Ordering code	Type reference and description	Number of modules	Pack
Motion Sensor			
2CLA224100N1302	N2241 PL - 110° motion sensor Max. power: Incandescent: 1.800W @230V AC/1.000W @127V AC • Halogen with electronic or ferromagnetic transformer: 750VA @230V AC/400VA @127V AC - Fluorescent lamps or motors: 400VA @230V / 200VA @127Vac • For automatic switching of devices dependent on motion and brightness • With integrated selector switch for automatic ON-OFF in the front side, Switch-off delay: 10 sec to 10 min or short-time pulse 1 sec adjustable (from the front side) • Detection range: 5 m radius Adjustable light set point level for activation (from the front side) • Detection angle: 110° Mounting height: 1, 2 m Auxiliary control with N2X04.X push-buttons	2	1

2CLA211900
N13022CLA221900
N1302

Ordering code	Type reference and description	Number of modules	Pack
Buzzer & Door Bell			
1SYK100001A1154	IIM2BUZR PL - Buzzer	2	5/100
2CLA211900N1302	N2119 PL - Buzzer	1	1
2CLA221900N1302	N2219 PL - Buzzer	2	1
2CLA222400N1302	N2224 PL - Electronic door bell 230 V AC	2	1

IVIE mechanisms - Silver

Ordering code	Type reference and description	Number of modules	Pack
Indicator			
1SYK100001A1153	IIM1INDI PL - Indicator	1	20/400

Ordering code	Type reference and description	Number of modules	Pack
Thermostat			
2CLA224050N1302	N2240.5 PL - Cover plate for digital thermostat	2	1



Ordering code	Type reference and description	Number of modules	Pack
Anthracite plate with frame			
1SYK100001A1171	IIP0133 PL - 1M plate	1	15/360
1SYK100001A1172	IIP0233 PL - 2M plate	2	15/360
1SYK100001A1173	IIPP343 PL - 3M plate power	3	10/240
1SYK100001A1174	IIP0343 PL - 3M plate	3	10/240
1SYK100001A1175	IIP0453 PL - 4M plate	4	10/190
1SYK100001A1176	IIP0683 PL - 6M plate	6	5/120
1SYK100001A1177	IIP0893 PL - 8M plate	8	5/120
1SYK100001A1178	IIP0855 PL - 8M plate square	8	5/95
1SYK100001A1179	IIP1286 PL - 12M plate	12	5/95
1SYK100001A1180	IIP1888 PL - 18M plate	18	5/40



Flush boxes

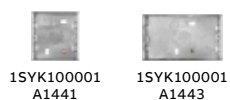

Ordering code	Type reference and description	Number of modules	Pack
Flush boxes			
1SYK100001A1441	IAB0233W - 1-2 M Metal Box	1/2	24
1SYK100001A1442	IAB0343W - 3 M Metal Box	3	18
1SYK100001A1443	IAB0453W - 4 M Metal Box	4	18
1SYK100001A1444	IAB0683W - 6 M Metal Box	6	12
1SYK100001A1445	IAB0893W - 8 M Metal Box	8	12
1SYK100001A1446	IAB0855W - 8 M Metal Box Square	8	7
1SYK100001A1447	IAB1286W - 12M Metal Box	12	5
1SYK100001A1448	IAB1888W - 18 M Metal Box	18	5

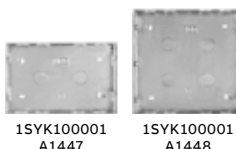
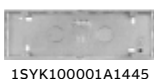

IVIE ABB-free@home®

Making home automation easier than ever

Installation steps and colour options*

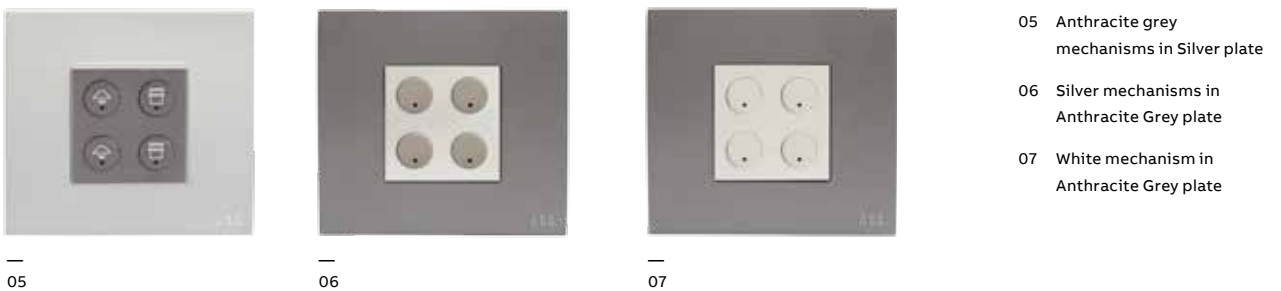
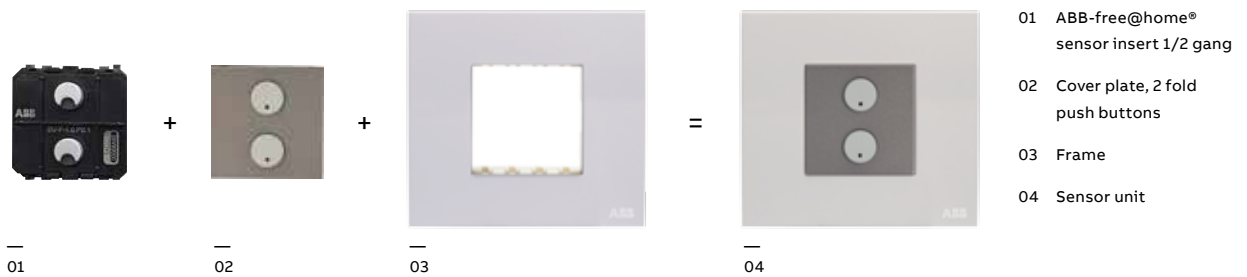

* Home automation solution with design and installation will be provided upon request.



IVIE

Inner frame dimensions

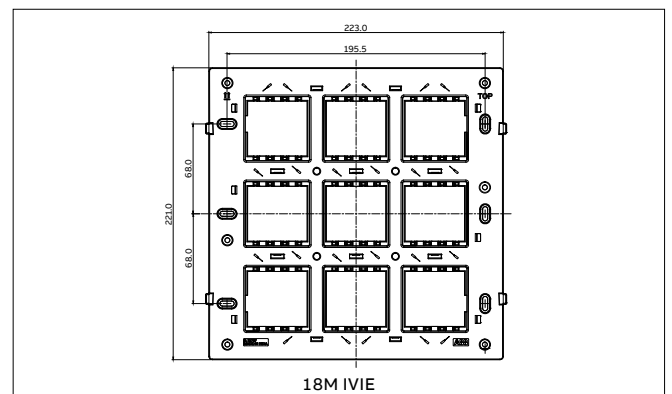
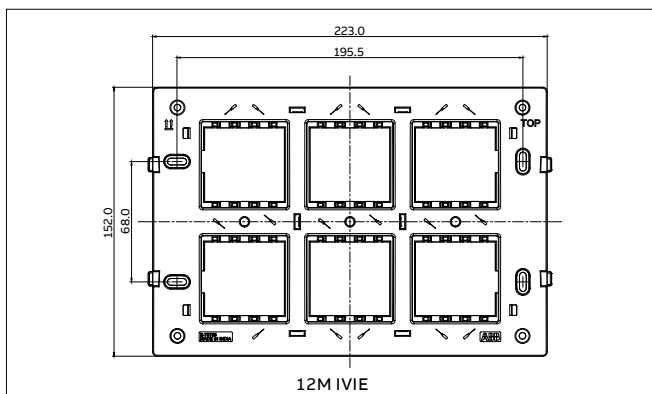
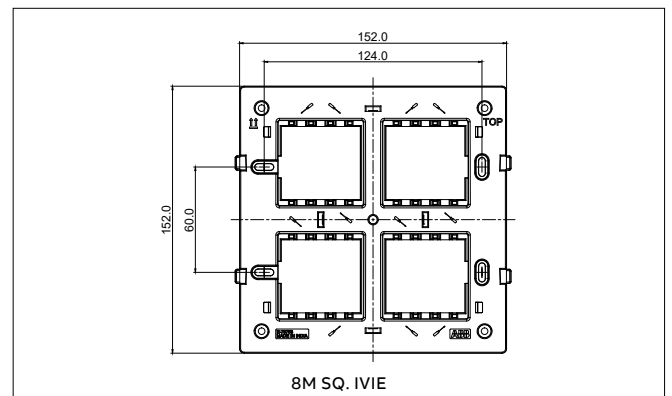
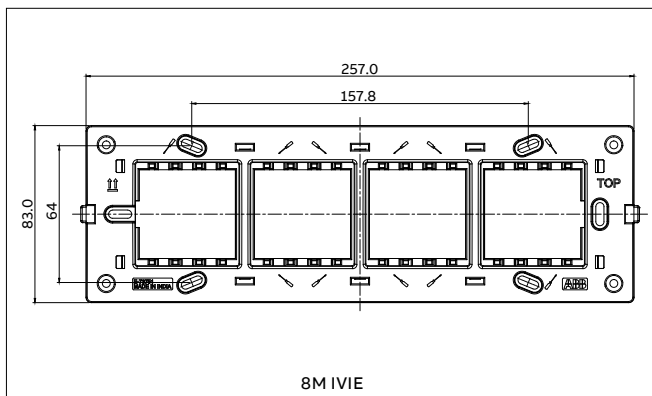
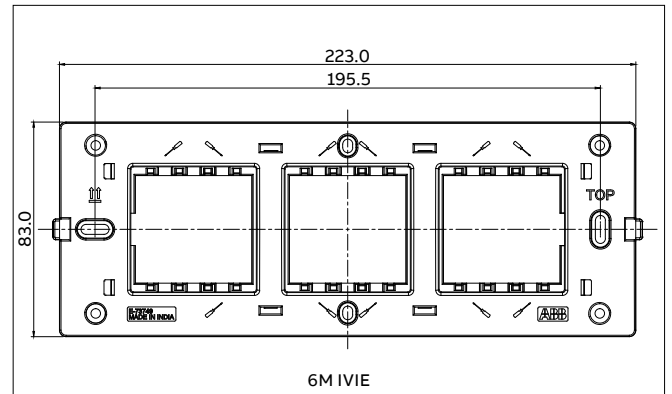
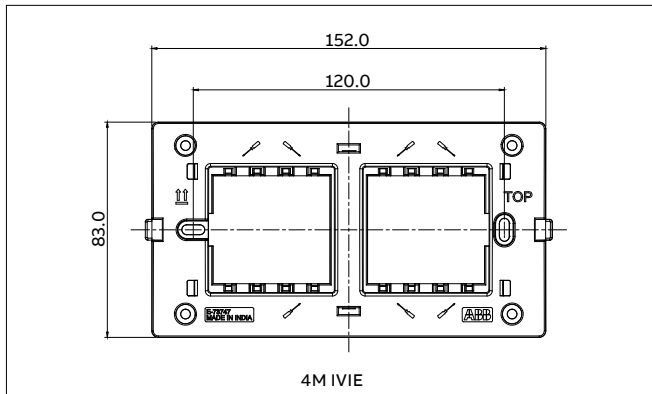
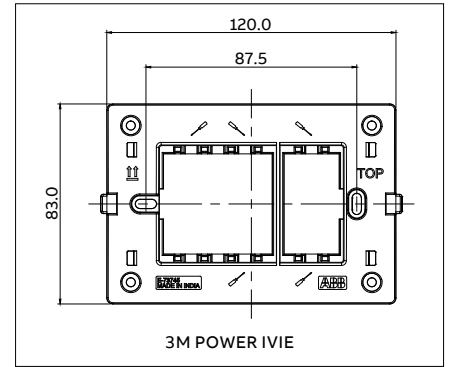
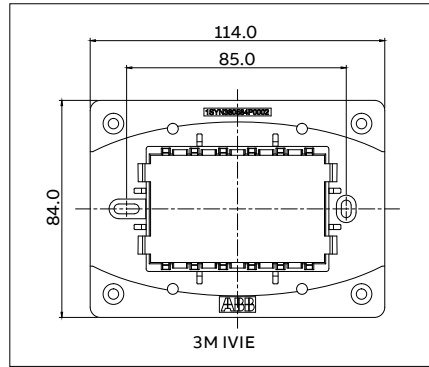
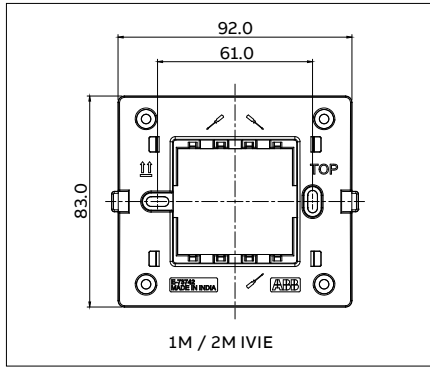

IVIE

Outer frame dimensions

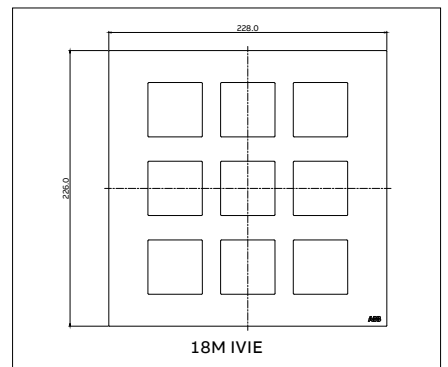
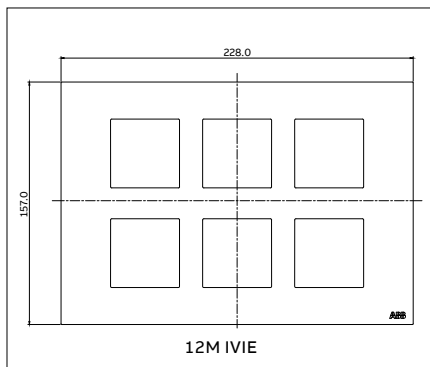
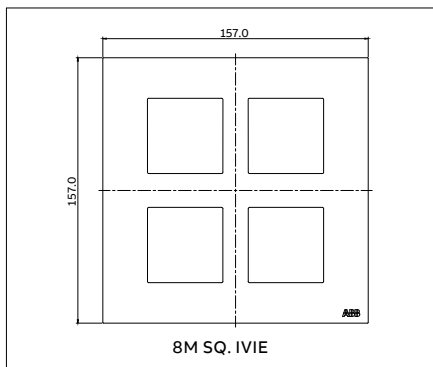
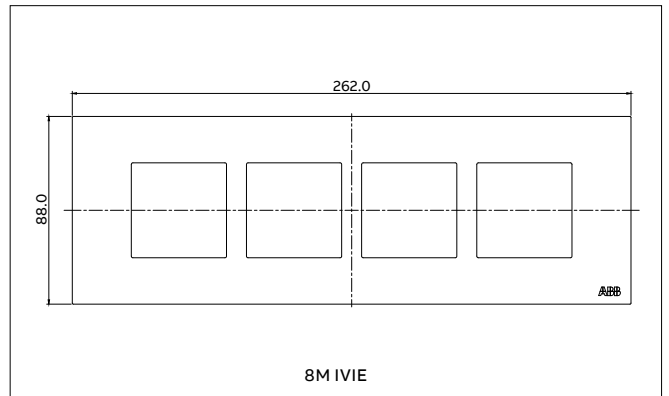
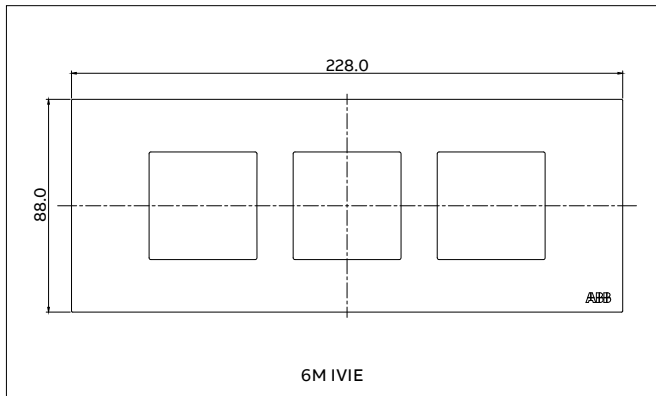
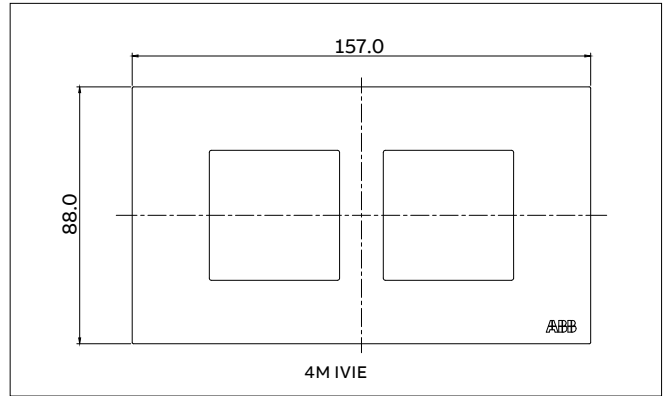
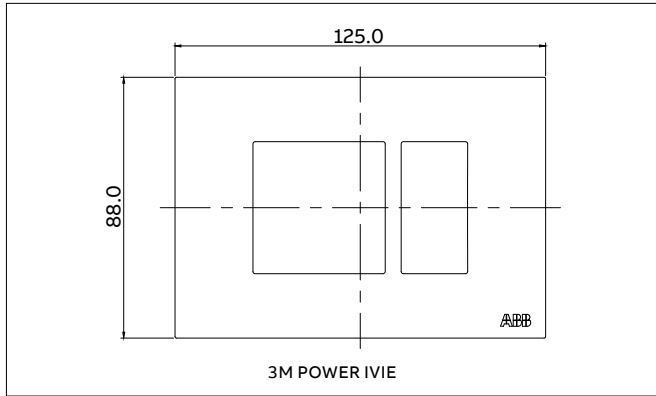
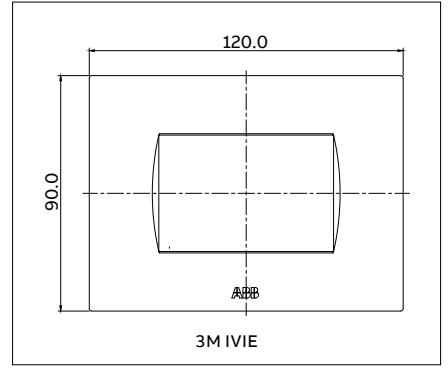
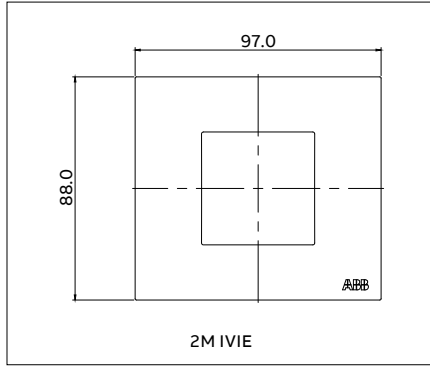
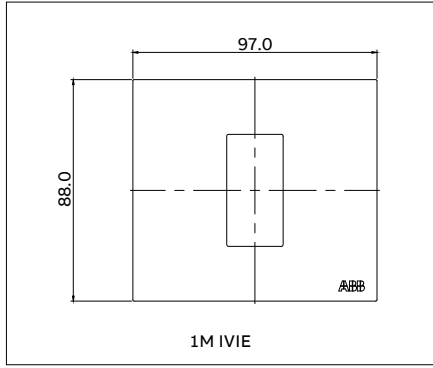

IVIE

Circuit connection diagrams

2 Pin socket

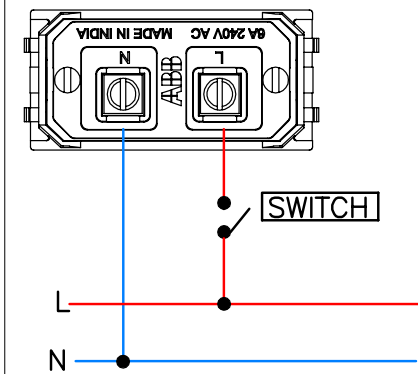

3+2 Pin socket

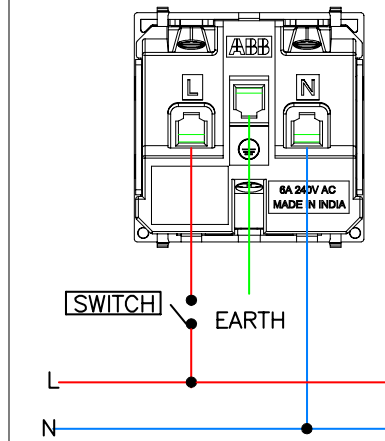

Ivie 6/16A socket

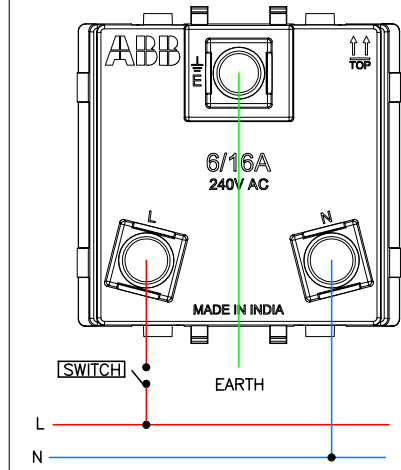

6A 2W switch

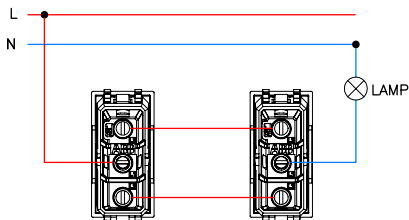

6A 1W switch

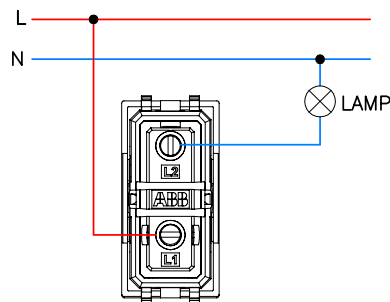

13A Universal socket

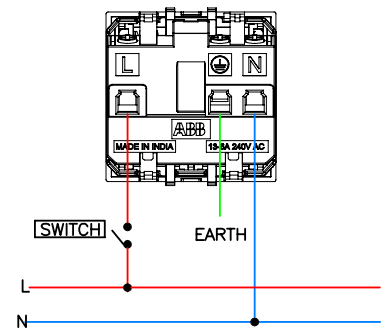

32A DP switch

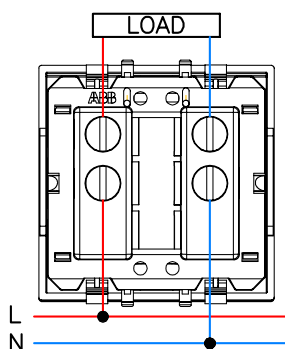

Additional information

We reserve the right to make technical changes or modify the contents of this document without prior notice. With regard to purchase orders, the agreed particulars shall prevail. ABB does not accept any responsibility whatsoever for potential errors or possible lack of information in this document.

We reserve all rights in this document and in the subject matter and illustrations contained therein. Any reproduction, disclosure to third parties or utilization of its contents – in whole or in parts – is forbidden without prior written consent of ABB.

